

Mudflap front MITSUBISHI L200, 2019->

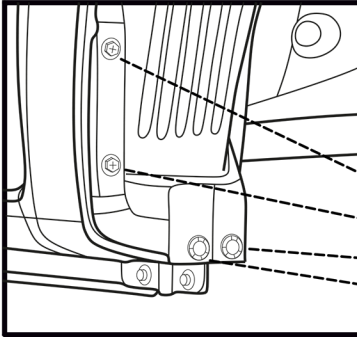



Preparation

Dismantle original mudflap.

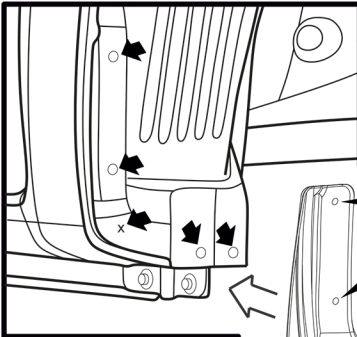
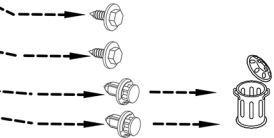
- 2x  Original screw
- 2x  Original plastic rivet



Installation

- 2x  Original screw
- 2x  Plastic rivet 6,5 x 18mm
- 1x  Screw 4,2 x 16mm

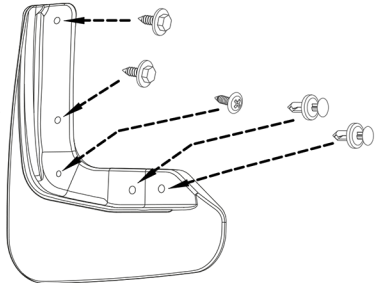

Art.: EXP.NLF.35.31.F15

Set package

Mudflap - 2pcs. Screw 4,2 x 16mm (TL-028)-2pcs
Plastic rivet 8 x 21mm (TL-031)-4pcs